

Please write clearly in block capitals.

Centre number

3	1	4	1	5
---	---	---	---	---

Candidate number

9	2	6	5
---	---	---	---

Surname Matheson

Forename(s) Lewis

Candidate signature 

I declare this is my own work.

A-level PHYSICS

Paper 1

A Level Physics Online . com

Time allowed: 2 hours

Materials

For this paper you must have:

- a pencil and a ruler
- a scientific calculator
- a Data and Formulae Booklet
- a protractor.

Instructions

- Use black ink or black ball-point pen.
- Fill in the boxes at the top of this page.
- Answer **all** questions.
- You must answer the questions in the spaces provided. Do not write outside the box around each page or on blank pages.
- If you need extra space for your answer(s), use the lined pages at the end of this book. Write the question number against your answer(s).
- Do all rough work in this book. Cross through any work you do not want to be marked.
- Show all your working.

Information

- The marks for questions are shown in brackets.
- The maximum mark for this paper is 85.
- You are expected to use a scientific calculator where appropriate.
- A Data and Formulae Booklet is provided as a loose insert.

For Examiner's Use	
Question	Mark
1	
2	
3	
4	
5	
6	
7-31	
TOTAL	



Section A

Answer **all** questions in this section.

0 1

Two stable isotopes of helium are ${}^4_2\text{He}$ and ${}^3_2\text{He}$.

0 1 . 1

An atom of ${}^4_2\text{He}$ is produced in a rock that contains uranium. It is produced following the radioactive decay of a ${}^{238}_{92}\text{U}$ atom. The decay also creates an atom of thorium (Th).Write an equation for the decay of ${}^{238}_{92}\text{U}$.

[2 marks]



0 1 . 2

A ${}^3_2\text{He}$ nucleus can be produced by the decay of a tritium nucleus ${}^3_1\text{H}$.

State and explain which exchange particle is responsible for this decay.

[2 marks]



A neutron decays into a proton (a down quark decays into an up quark) by the weak interaction $\therefore W$ boson.

To conserve charge it must be a W^- boson.

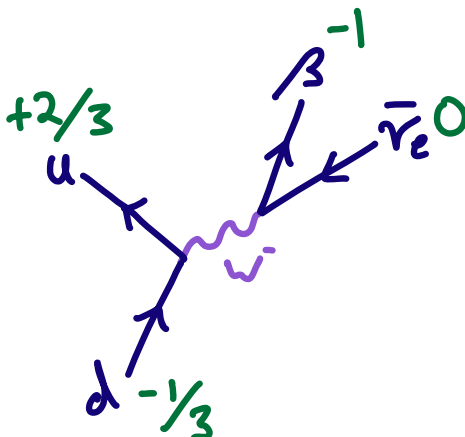

Helium was discovered by analysing the light in the **absorption** spectrum of the Sun.

Figure 1 shows the positions of the brightest lines, labelled **A** to **F**, in the **emission** spectrum of helium. The brightest lines in the emission spectra of sodium and hydrogen are also shown.

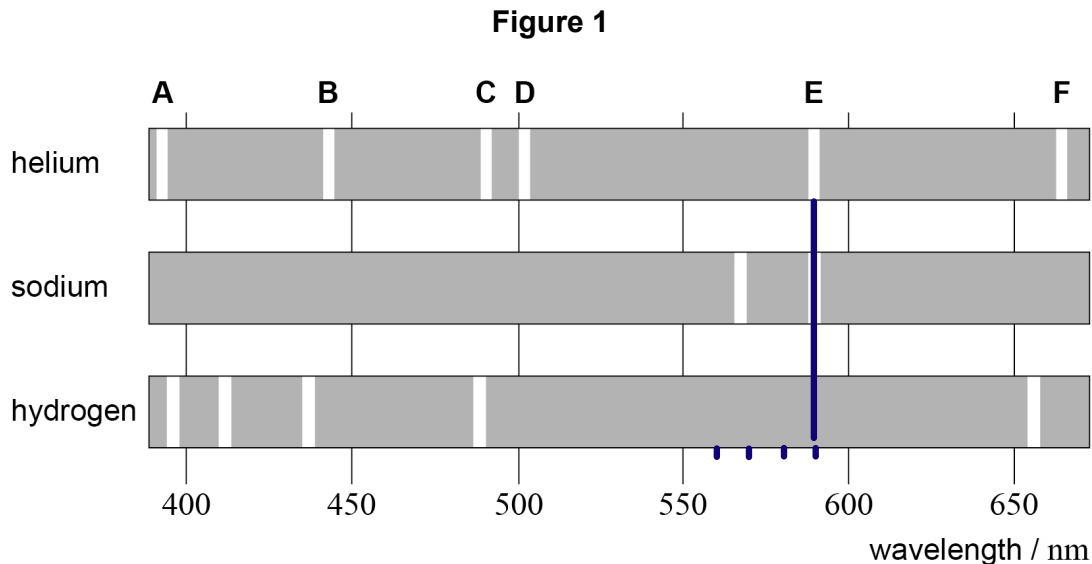

0 1 . 3

Before helium was identified, some scientists suggested that the lines of the helium spectrum seen in the absorption spectrum of the Sun were due to the presence of sodium and hydrogen.

Discuss, with reference to the lines **A** to **F** in **Figure 1**, the evidence for and against this suggestion.

[2 marks]

Line C is seen in hydrogen and line E is found in sodium which support this suggestion. ✓

However, line D is missing from both hydrogen and sodium so must come from a different element. ✓

Question 1 continues on the next page

Turn over ►



0 1 . 4

Calculate, in eV, the change in energy level responsible for the spectral line labelled E in Figure 1.

[3 marks]

$$\lambda \approx 590 \times 10^{-9} \text{ m} \checkmark$$

$$E = \frac{hc}{\lambda} = \frac{6.63 \times 10^{-34} \times 3.00 \times 10^8}{590 \times 10^{-9}} \checkmark$$

$$E = 3.37 \times 10^{-19} \text{ J}$$

$$\text{J} \rightarrow \text{eV} \quad 3.37 \times 10^{-19} \div 1.60 \times 10^{-19} = 2.1070$$

change in energy level = 2.11 \checkmark eV

0 1 . 5

Explain, with reference to the processes within an atom, the difference between an emission spectrum and an absorption spectrum.

[3 marks]

An absorption spectrum is produced when electrons move to a higher energy level, as a photon is absorbed where the photon is the energy carrier. \checkmark

An emission spectrum produced as photons are emitted as the atom moves to a lower energy state. \checkmark



0 2

Carbon-14 decays into nitrogen-14 with the release of a beta (β^-) particle and an antineutrino ($\bar{\nu}_e$).

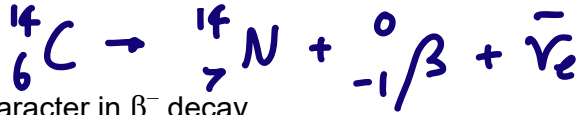

0 2 . 1

State the change of quark character in β^- decay.

[1 mark]

From down to up ✓ (as a neutron udd decays to a proton uud)

0 2 . 2

Figure 2 shows the distribution of kinetic energies of β^- particles from the decay of carbon-14.

Figure 2

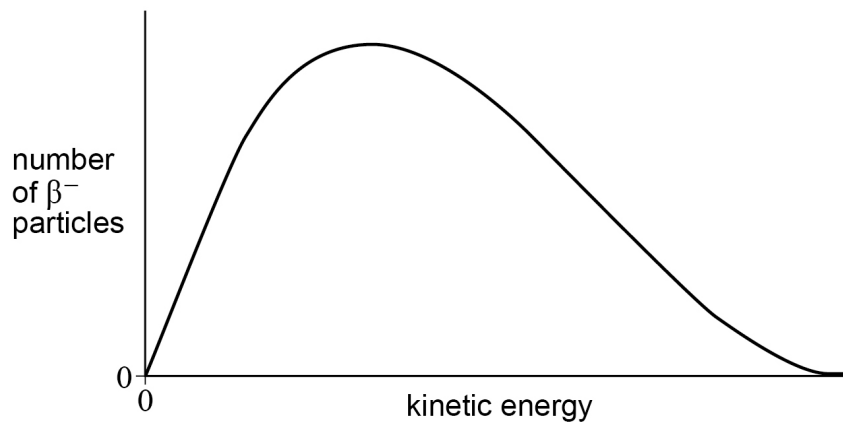

Explain how Figure 2 supports the existence of the antineutrino.

[2 marks]

For a C-14 there is a fixed quantity of energy released, but the graph shows a range of energies for the beta particles. \therefore the extra energy must be transferred to another particle with no charge (the neutrino). ✓
This must be an anti-lepton to conserve lepton number. ✓

Question 2 continues on the next page

Turn over ►



The existence of the antineutrino was confirmed by experiments in which antineutrinos interact with protons. The equation for this interaction is:

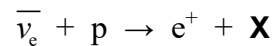

0 2 . 3 Identify particle X.

[1 mark]

Neutron ✓

0 2 . 4 The positron released in this interaction is annihilated when it encounters an electron. A pair of gamma photons is then produced. Particle X can be absorbed by a nucleus. This produces another gamma ray. **Table 1** contains data for three gamma photons detected during an antineutrino–proton interaction experiment.

Table 1

Gamma photon	Photon energy / J
G1	5.0×10^{-14}
G2	6.6×10^{-14}
G3	1.0×10^{-13}

Deduce which of the three gamma photons could have been produced by positron annihilation.



[3 marks]

Rest energy of $e^+/e^- = 0.511 \text{ MeV}$

Total rest energy = $2 \times 0.511 = 1.022 \text{ MeV}$ ✓

2 photons produced $\therefore 0.511 \text{ MeV}$ per photon

$$0.511 \times 10^6 \times 1.60 \times 10^{-19} = 8.18 \times 10^{-14} \text{ J} \quad \checkmark$$

$8.18 \times 10^{-14} \text{ J}$ is the minimum energy of each photon produced, which is greater than G1 and G2, so it must be G3. ✓



Turn over for the next question

*Do not write
outside the
box*

**DO NOT WRITE ON THIS PAGE
ANSWER IN THE SPACES PROVIDED**

Turn over ►



0 3

Figure 3 shows a garden gate with a pulley system designed to close the gate.

Figure 3

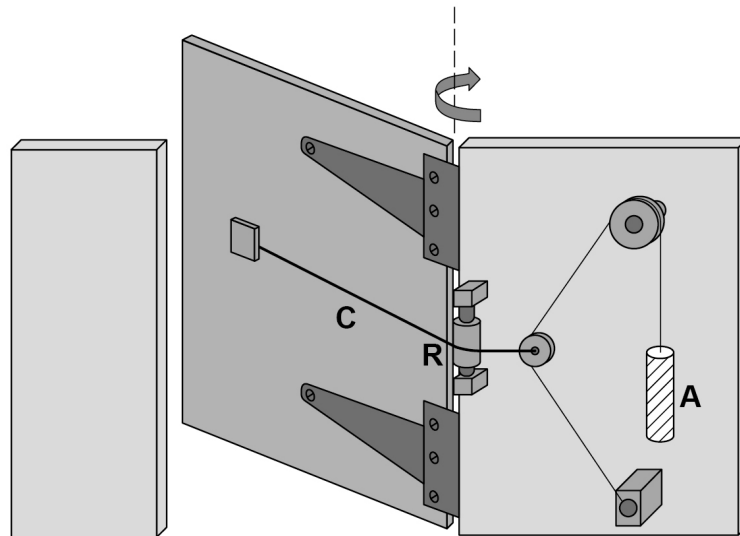

The pulley system raises weight **A** when the gate is opened. When the gate is released, **A** falls. The horizontal cable **C** passes over pulley **R**. The tension in cable **C** causes the gate to close.

Weight **A** is a solid cylinder with the following properties:

$$\text{diameter} = 4.8 \times 10^{-2} \text{ m}$$

$$\text{length} = 0.23 \text{ m}$$

$$\text{weight} = 35 \text{ N}$$

Table 2 gives the density of three available materials.

Table 2

Material	Density / kg m^{-3}
concrete	2.4×10^3
iron	7.8×10^3
brass	8.6×10^3



0 3 . 1 Deduce which **one** of the three materials is used for A.

[3 marks]

$$\rho = \frac{m}{V} = \frac{W/g}{L \cdot \frac{\pi d^2}{4}} = \frac{4W}{L\pi d^2 g} \quad \checkmark$$

$$\rho = \frac{4 \times 35}{0.23 \times \pi \times (4.8 \times 10^{-2})^2 \times 9.81}$$

$$\rho = 8572 = 8.6 \times 10^3 \text{ kg m}^{-3} \quad \checkmark$$

\therefore Brass \checkmark

Question 3 continues on the next page

Turn over ►



Figure 4 shows the pulley arrangement when the gate is closed.

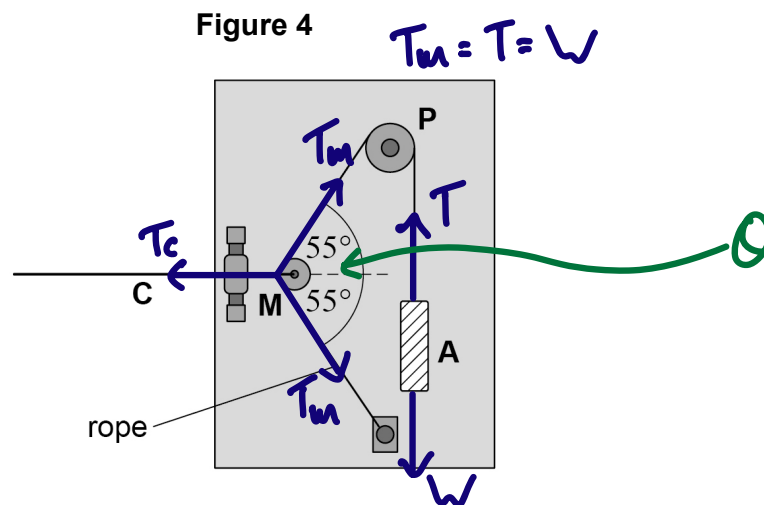

Pulleys **P** and **M** are frictionless so that the tension in the rope attached to **A** is equal to the weight of **A**.

A weighs 35 N and the weight of moveable pulley **M** is negligible.

- 0 3 . 2 Calculate the tension in the horizontal cable **C** when the gate is closed.

[2 marks]

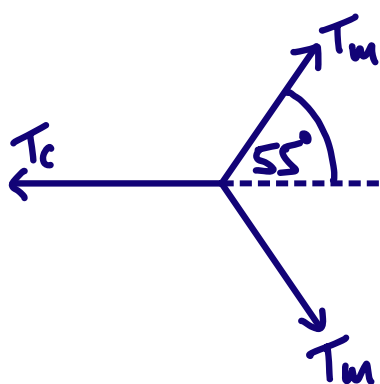

$$T_c = 2 \times \text{horizontal component of } T_M$$

$$T_c = 2 \times 35 \times \cos 55^\circ \checkmark$$

$$T_c = 40.15$$

tension = 40 \checkmark N

- 0 3 . 3 Pulley **M** is pulled to the left as the gate is opened.

Explain why this increases the tension in the horizontal cable **C**.

[2 marks]

Angle θ decreases $\checkmark \therefore \cos \theta$ increases.

A greater component of tension T_M is horizontal $\therefore T_c$ increases. \checkmark

$$T_c = 2 T_M \cos \theta \therefore T_c \propto \cos \theta$$



Question 3 continues on the next page

*Do not write
outside the
box*

**DO NOT WRITE ON THIS PAGE
ANSWER IN THE SPACES PROVIDED**

Turn over ►



0 3 . 4

Figure 5 shows a plan view with the gate open. The horizontal cable **C** passes over pulley **R** and is attached to the door at **D**.

The angle between the door and the horizontal cable **C** is 12° .

The horizontal distance between the hinge and **D** is 0.95 m.

Figure 5

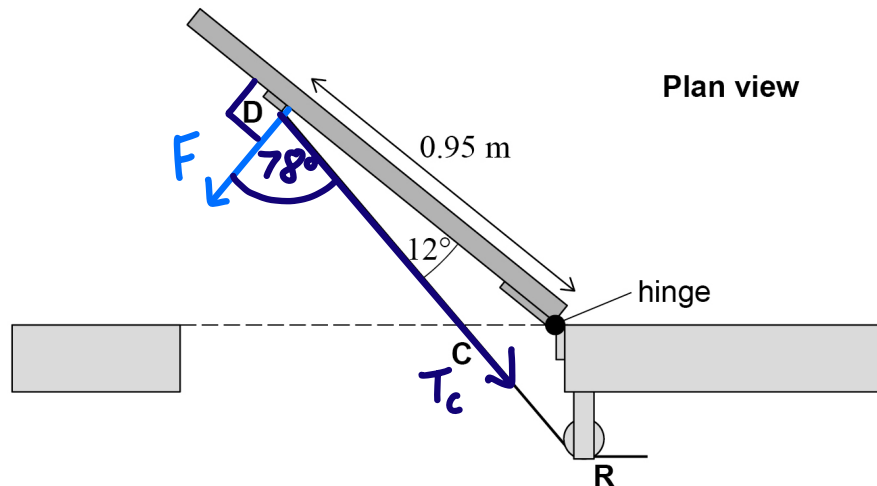

The tension in the horizontal cable **C** is now 41 N.

Calculate the moment of the tension about the hinge.

[2 marks]

Perpendicular force, F , is the component of T_c at 90° to the door.

$$M = Fd = 41 \cos 78 \times 0.95 = 8.018$$

moment = 8.1 N m



0 3 . 5

The same system is attached to an identical gate with stiffer hinges. Now the system does not supply a sufficiently large moment to close the gate.

Discuss **two** independent changes to the design to increase the moment about the hinges due to horizontal cable **C**.

[4 marks]

1 Increase tension ✓ by increasing the weight of A. ✓

2 Move D further ✓ from the hinge, increasing the perpendicular distance. ✓

13

Turn over for the next question

Turn over ►



0 4

A student assembles the circuit in **Figure 6**.

Figure 6

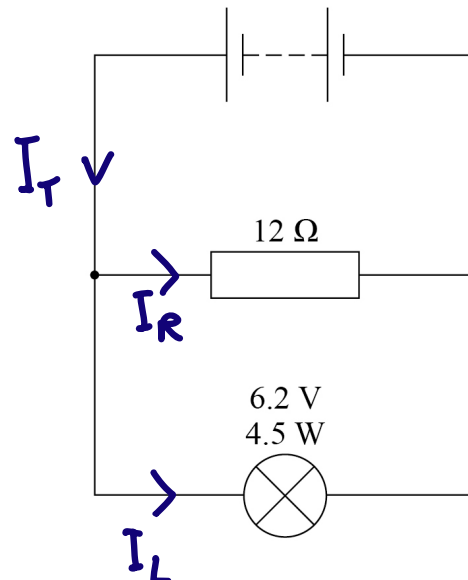

The battery has an internal resistance of 2.5 Ω.

0 4 . 1

Show that the resistance of the 6.2 V, 4.5 W lamp at its working potential difference (pd) is about 9 Ω.

$$P = \frac{V^2}{R} \quad R = \frac{V^2}{P} = \frac{6.2^2}{4.5} = \underline{8.54} \approx 9 \Omega \quad [1 \text{ mark}]$$

0 4 . 2

The terminal pd across the battery is 6.2 V.

Calculate the emf of the battery.

[3 marks]

$$I_L = \frac{V}{R} = \frac{6.2}{8.54} = 0.726 \text{ A} \quad \checkmark$$

$$I_R = \frac{V}{R} = \frac{6.2}{12} = 0.517 \text{ A}$$

$$I_T = I_R + I_L = 1.243 \quad \checkmark$$

$$\mathcal{E} = I(R+r) = V + Ir = 6.2 + (1.243 \times 2.5)$$

$$\mathcal{E} = 9.306 \text{ V}$$

$$\text{emf} = \underline{9.3} \quad \checkmark \quad \text{V}$$



The student makes a variable resistor to control the brightness of the lamp.
Figure 7 shows her circuit.

Figure 7

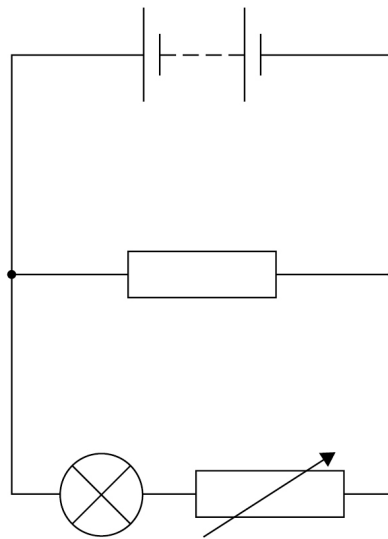

0 4 . 3

She uses a resistance wire with a diameter of 0.19 mm to make the variable resistor.
A 5.0 m length of this wire has a resistance of 9.0 Ω .

Calculate the resistivity of the wire.

[3 marks]

$$\rho = \frac{RA}{L} = \frac{R \pi d^2}{4L} = \frac{9.0 \times \pi \times (0.19 \times 10^{-3})^2}{4 \times 5.0}$$

$$\rho = 5.10 \times 10^{-3}$$

resistivity = 5.1 Ω m

Question 4 continues on the next page

Turn over ►



0 4 . 4

Figure 8 shows the 5.0 m length of wire wrapped around a tube to make the variable resistor.

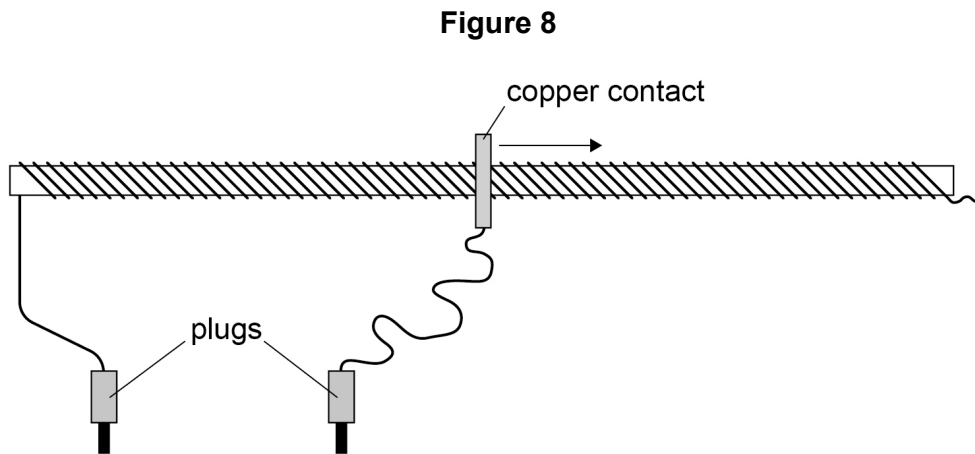

Two plugs connect the variable resistor into the circuit. A moveable copper contact is used to vary the length of wire in series with the lamp.

When the contact is placed on the tube at one particular position, the lamp is dim. The contact is then moved slowly to the right as shown in **Figure 8**.

Explain, without calculation, what happens to the brightness of the lamp as the contact is moved.

[2 marks]

Resistance increases ✓ ∴ reduces current
through the lamp ∴ it gets dimmer. ✓



0 4 . 5

The student now makes a different circuit by connecting the variable resistor **in parallel** with the lamp.

The contact is returned to its original position on the tube as shown in **Figure 8** and the lamp is dim. The contact is again slowly moved to the right.

Explain, without calculation, what happens to the brightness of the lamp as the contact is moved.

[2 marks]

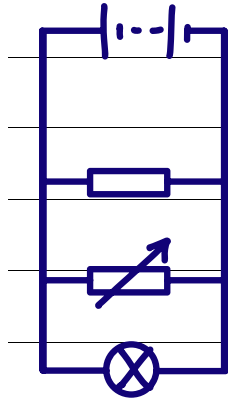

As the resistance increases, this increases the total resistance (R) of the circuit. ✓

This reduces the p.d. dropped across internal resistance of the cell, increasing terminal p.d. ∴ lamp gets brighter. ✓

11

Turn over for the next question

$$\mathcal{E} = V + Ir \quad \rightarrow \quad V = \mathcal{E} - Ir$$

Turn over ►



0 5

A teacher sets up a demonstration to show the relationship between circular motion and simple harmonic motion (SHM). She places a block on a turntable at a point 0.25 m from its centre, as shown in **Figure 9**.

Figure 9

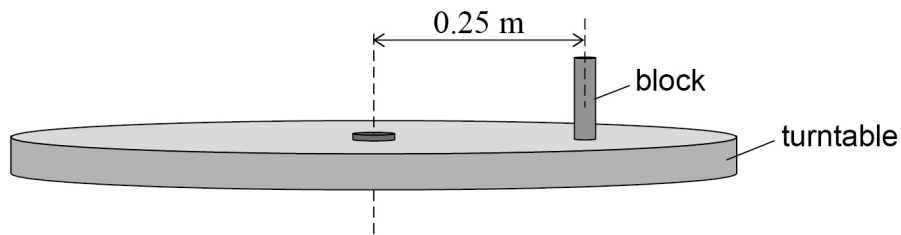

The turntable rotates with an angular speed of 1.8 rad s^{-1} and the block does not slip.

0 5 . 1

Calculate the time taken for the turntable to complete one revolution.

[2 marks]

$$\omega = \frac{\theta}{t} \quad t = T \text{ when } \theta = 2\pi$$

$$T = \frac{\theta}{\omega} = \frac{2\pi}{1.8} = 3.49$$

time = 3.5 s



0 5 . 2

Figure 10 shows a plan view of the turntable and block.
The turntable rotates in a clockwise direction.

Draw an arrow on **Figure 10** to show the direction of the resultant force on the block.

[1 mark]

Figure 10

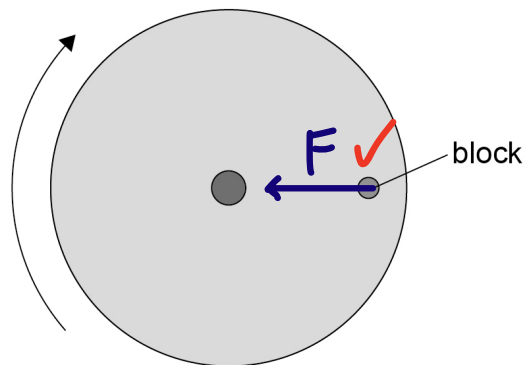

0 5 . 3

The mass of the block is 0.12 kg.

Calculate the magnitude of the resultant force on the block.

[2 marks]

$$F = m \omega^2 r \checkmark = 0.12 \times 1.8^2 \times 0.25$$

$$F = 0.0972$$

magnitude of force = 0.097 \checkmark N

Question 5 continues on the next page

Turn over ►



- 0 5 . 4 Describe, with reference to one of Newton's laws of motion, the evidence that a resultant force is acting on the block.

[2 marks]

The block is constantly changing direction,
its velocity is changing \checkmark \therefore its accelerating
 \therefore a resultant force is acting on it.
This is Newton's 2nd law. \checkmark

- 0 5 . 5 The teacher adjusts the angular speed of the turntable so that the block completes one rotation every 2.50 s.
She sets up a simple pendulum above the centre of the turntable so that it swings in phase with the movement of the block.

Calculate the length of the simple pendulum.

[2 marks]

$$T = 2\pi \sqrt{\frac{L}{g}} \quad T^2 = 4\pi^2 \frac{L}{g}$$

$$L = \frac{T^2 g}{4\pi^2} = \frac{2.50^2 \times 9.81}{4\pi^2} = 1.55$$

length = 1.55 \checkmark m



0 5 . 6

A lamp is used to project shadow images of the block and pendulum bob on a screen. Both shadows appear to move with SHM across the screen. **Figure 11** shows the images on the screen at one instant.

Figure 11

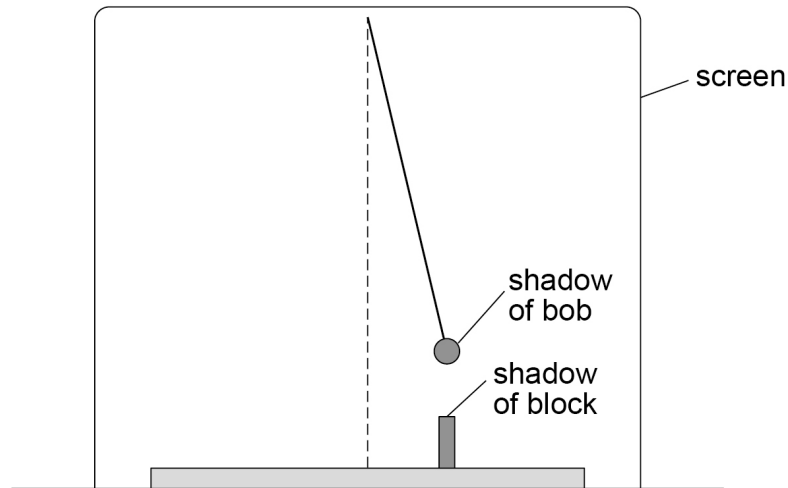

Initially the shadows move in phase with the same amplitude.

Air resistance affects the motion of the pendulum.

Suggest the effect this has on the amplitude relationship and the phase relationship between the moving shadows.

[2 marks]

amplitude Amplitude of the block shadow remains constant, but the amplitude of the pendulum shadow decreases. ✓

phase This remains constant, as time period of pendulum independent of amplitude. ✓

11

Turn over ►



0 6

Two transparent prisms **A** and **B** of different refractive indices are placed in contact to produce a rectangular block.
Figure 12 shows the path of a ray, incident normally on **A**, refracting as it crosses the boundary between the prisms.

Figure 12

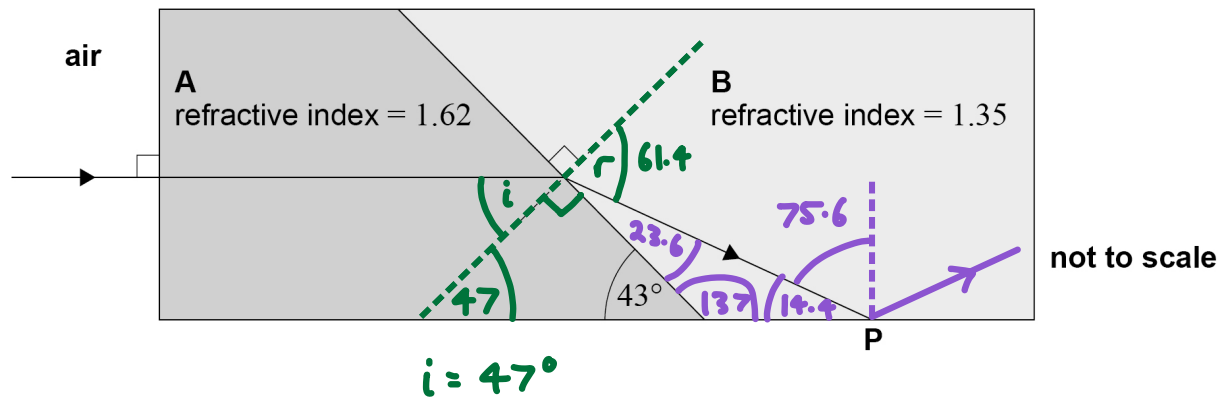

0 6 . 1

Explain how the path of the ray shows that the refractive index of **A** is greater than the refractive index of **B**.

[1 mark]

Light refracts away from the normal
 ($r > i$) therefore it speeds up \checkmark \therefore the
 refractive index of A is greater than B.



0 6 . 2 Show that the angle of refraction of the ray in **B** is about 60° .

[2 marks]

$$n_1 \sin \theta_1 = n_2 \sin \theta_2$$

$$n_A \sin \theta_A = n_B \sin \theta_B$$

$$\theta_A = i \quad \theta_B = r$$

$$r = \sin^{-1} \left(\frac{n_A}{n_B} \sin i \right) \checkmark$$

$$r = \sin^{-1} \left(\frac{1.62}{1.35} \sin 47 \right)$$

$$r = \underline{61.4^\circ} \checkmark$$

0 6 . 3 Draw, on **Figure 12**, the path of the ray immediately after it reaches **P**. Justify your answer with calculations.

[3 marks]

$$\sin \theta_c = \frac{n_2}{n_1}$$

$$\theta_c = \sin^{-1} \left(\frac{n_{\text{air}}}{n_B} \right) = \sin^{-1} \left(\frac{1}{1.35} \right) = 47.8^\circ \checkmark$$

$$i = 75.6^\circ \checkmark \quad i > \theta_c \quad \therefore \text{TIR} \checkmark$$

6

END OF SECTION A

Turn over ►



Section B

Each of Questions **07** to **31** is followed by four responses, **A, B, C** and **D**.

For each question select the best response.

Only **one** answer per question is allowed.

For each question, completely fill in the circle alongside the appropriate answer.

CORRECT METHOD

WRONG METHODS

If you want to change your answer you must cross out your original answer as shown. 

If you wish to return to an answer previously crossed out, ring the answer you now wish to select as shown. 

You may do your working in the blank space around each question but this will not be marked. Do **not** use additional sheets for this working.

07 Which two quantities have the base unit $\text{kg m}^2 \text{s}^{-2}$?

[1 mark]

- A kinetic energy and momentum kg m s^{-1}
 - B kinetic energy and Young modulus Pa
 - C work done and the moment of a couple $\text{kg m}^2 \text{s}^{-2}$
 - D work done and pressure $\text{kg m}^2 \text{s}^{-2}$
- Handwritten notes: 'J' above A and B, 'Pa' above D, and arrows pointing from the $\text{kg m}^2 \text{s}^{-2}$ units to options C and D.*

08 Which gives SI prefixes in descending order of magnitude?

[1 mark]

- A G p m $9 - 12 - 5$
 - B M G n $6 - 9 - 9$
 - C m n μ $-3 - 9 - 6$
 - D m μ p $-3 - 6 - 12$
- Handwritten notes: A list of prefixes and their exponents: G (9), M (6), k (3), m (-3), μ (-6), n (-9), p (-12).*



0 9 A car travels at 100 km h^{-1} on a motorway.

What is an estimate of its kinetic energy?

[1 mark]

A 10^4 J

B 10^6 J

C 10^8 J

D 10^{10} J

$$m \approx 1500 \text{ kg}$$

$$v = \frac{100 \times 10^3}{3600} = 27.7 \text{ m s}^{-1}$$

$$E_k = \frac{1}{2}mv^2 = 5.79 \times 10^5 \text{ J} \approx 10^6$$

1 0 What is the specific charge of a ${}^{13}_6\text{C}$ nucleus?

[1 mark]

A $4.4 \times 10^7 \text{ C kg}^{-1}$

B $5.2 \times 10^7 \text{ C kg}^{-1}$

C $8.3 \times 10^7 \text{ C kg}^{-1}$

D $2.1 \times 10^8 \text{ C kg}^{-1}$

$$\frac{Q}{m} = \frac{6 \times 1.60 \times 10^{-19}}{13 \times 1.67 \times 10^{-27}} = 4.42 \times 10^7$$

1 1 Which row describes the variation with distance of the strong nuclear force?

[1 mark]

	Attractive	Repulsive	
A	beyond 3 fm	from 0.5 fm to 3 fm	<input type="radio"/>
B	from 0.5 fm to 3 fm	beyond 3 fm	<input type="radio"/>
C	from 0.5 fm to 3 fm	up to 0.5 fm	<input checked="" type="radio"/>
D	up to 0.5 fm	from 0.5 fm to 3 fm	<input type="radio"/>

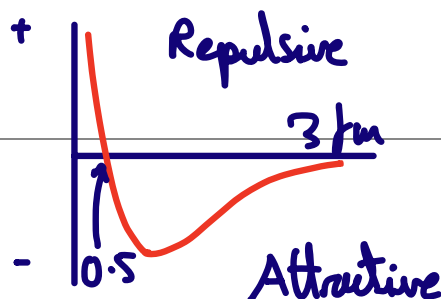

Turn over ►



1 2 Which statement is correct?

[1 mark]

- A All strange particles are mesons.
- B Strange particles are always created in pairs.
- C Strangeness can only change in strong interactions.
- D Strangeness can only have a value of 0 or -1

Strangeness
conserved in strong
interactions

1 3 Which combination of quarks is possible?

[1 mark]

- A sd
- B sū
- C sūd
- D ud

Pairs must be quark - antiquark

1 4 In photoelectricity, V_s is the stopping potential.

What quantity is eV_s ?

[1 mark]

- A energy of an incident photon
- B maximum kinetic energy of a photoelectron
- C threshold frequency \times the Planck constant
- D work function

$$eV_s = \max E_k$$

$1\text{eV} = E_k$ gained by e^- accelerated through 1V



1 5 A fluorescent tube contains a gas.

The coating of the tube

[1 mark]

- A becomes ionised by the gas and emits photons of ultraviolet light.
- B absorbs photons of ultraviolet light from the gas and emits visible light.
- C absorbs photons of ultraviolet light from the gas and emits photoelectrons.
- D absorbs several photons of visible light from the gas and then emits one photon of ultraviolet light.

1 6 Which row gives evidence for the wave nature of electrons and evidence for the particulate nature of light?

[1 mark]

	Wave nature of electrons	Particulate nature of light	
A	electron diffraction	photoelectric effect	<input checked="" type="radio"/>
B	electron diffraction	single-slit diffraction	<input type="radio"/>
C	photoelectric effect	single-slit diffraction	<input type="radio"/>
D	photoelectric effect	electron diffraction	<input type="radio"/>

1 7 Which particle has the smallest de Broglie wavelength?

[1 mark]

- A an electron moving at $4 \times 10^3 \text{ m s}^{-1}$
- B a proton moving at $4 \times 10^3 \text{ m s}^{-1}$
- C an electron moving at $8 \times 10^5 \text{ m s}^{-1}$
- D a proton moving at $8 \times 10^5 \text{ m s}^{-1}$

$$\lambda = \frac{h}{mv}$$

\therefore greatest mass
and speed

No calculation needed

Turn over ►



1 8

A longitudinal wave of frequency 660 Hz travels through a medium. The wave speed is 330 m s^{-1} .

Which statement describes the motion of a particle in the wave?

- A It is travelling at a speed of 330 m s^{-1} .
- B It moves in phase with a particle in the wave 25 cm away.
- C It oscillates with a time period of 1.5 ms.
- D It changes direction 660 times every second.

$$\lambda = \frac{c}{f} = 0.50$$

[1 mark]

$0.25 \text{ m} \rightarrow$ anti phase

$$T = \frac{1}{f} = 0.00152 \text{ s} = 1.5 \text{ ms}$$

1 9

The frequency of the first harmonic of a standing wave on a string is f . The tension in the string is T . The tension is increased to $4T$ without changing the length or mass of the string.

Which harmonic has a frequency $2f$ after this change?

- A first
- B second
- C third
- D fourth

$$f = \frac{1}{2L} \sqrt{\frac{T}{\mu}}$$

$$f = \frac{1}{2L} \sqrt{\frac{4T}{\mu}} = 2 \times \frac{1}{2L} \sqrt{\frac{T}{\mu}} = 2f$$

[1 mark]

2 0

Light of wavelength $5.2 \times 10^{-7} \text{ m}$ is used in a Young's double-slit experiment. The distance from the slits to the screen is 1.5 m. The width of ten fringes is 3.5 cm.

What is the separation of the two slits?

- A $2.2 \times 10^{-5} \text{ m}$
- B $9.9 \times 10^{-5} \text{ m}$
- C $1.1 \times 10^{-4} \text{ m}$
- D $2.2 \times 10^{-4} \text{ m}$

$$w = \frac{3.5 \times 10^{-2}}{10} = 3.5 \times 10^{-3} \text{ [1 mark]}$$

$$s = \frac{\lambda D}{w} = \frac{5.2 \times 10^{-7} \times 1.5}{3.5 \times 10^{-3}} = 2.23 \times 10^{-4} \text{ m}$$



2 1 Monochromatic light of wavelength 5.8×10^{-7} m is incident normally on a plane transmission diffraction grating that has a slit separation of 2.5×10^{-6} m.

How many maxima are produced by the grating?

A 4

B 5

C 8

D 9

$$n = \frac{d \sin \theta}{\lambda} \quad \text{Max at } 90^\circ \quad [1 \text{ mark}]$$

$$\therefore \sin \theta = 1$$

$$n = \frac{d}{\lambda} = \frac{2.5 \times 10^{-6}}{5.8 \times 10^{-7}} = 4.3$$

$$\therefore 4 \text{ either side} \quad \text{Total} = 4 + 1 + 4 = 9$$

2 2 An aeroplane flies horizontally at 150 m s^{-1} along a bearing 60° east of north.

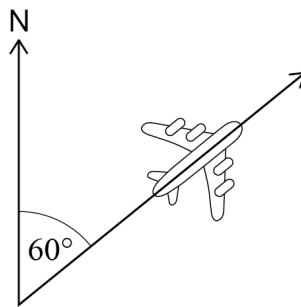

How far north from its starting position is the aeroplane after one hour?

A 270 km

B 470 km

C 510 km

D 540 km

$$s = v_n t$$

$$s = 150 \cos 60 \times 3600$$

$$s = 270\,000 \text{ m}$$

[1 mark]

Turn over ►



2 3

A ball is thrown vertically upwards and returns to its original position 2.4 s later. The effect of air resistance is negligible.

What is the total distance travelled by the ball?

[1 mark]

A 5.9 m

B 7.1 m

C 14 m

D 28 m

At max height

$$v = 0 \quad a = -9.81 \quad t = 1.2 \quad s = ?$$

$$s = vt - \frac{1}{2}at^2 = \frac{1}{2} \times 9.81 \times 1.2^2$$

$$s = 7.06 \text{ m}$$

$$S_T = 2 \times 7.06 = 14.1 \text{ m}$$

2 4

A truck of mass 2.1×10^3 kg tows a car of mass 1.3×10^3 kg along a horizontal road. The total resistive force on the car is 1100 N. The acceleration of the car and truck is 2.3 m s^{-2} .

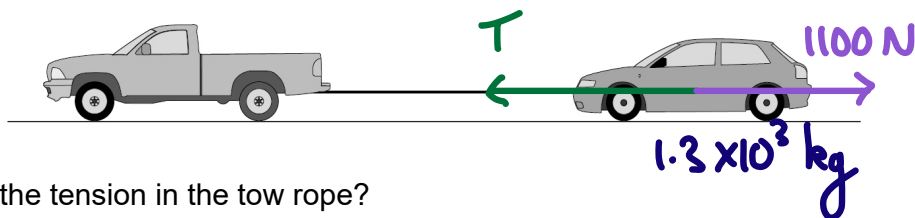

What is the tension in the tow rope?

[1 mark]

A 3000 N

B 4100 N

C 7800 N

D 8900 N

$$F = ma$$

$$T - 1100 = 1.3 \times 10^3 \times 2.3$$

$$T = 4090 \text{ N}$$



- 2 5** A parachutist descends to the ground at a constant speed with the parachute open.

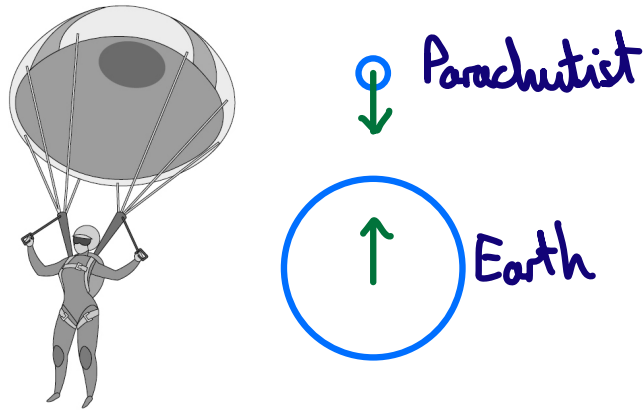

Which force, together with the parachutist's weight, makes a pair according to Newton's third law of motion?

[1 mark]

- A the drag force on the parachutist from the air
- B the tension in the strings of the parachute
- C the gravitational force of the parachutist on the Earth
- D the lift force on the parachute from the air

- 2 6** A tennis ball has a mass of 58 g.
The ball is dropped from rest from a height of 1.8 m above the ground and falls vertically.
The ball rebounds vertically to a height of 1.1 m.
The effect of air resistance is negligible.

What is the change in momentum of the ball during its collision with the ground?

[1 mark]

- A 0.040 N s
- B 0.075 N s
- C 0.215 N s
- D 0.614 N s

$$\Delta p = m \Delta v$$

Before

$$v^2 = u^2 + 2as$$

$$v = \sqrt{2 \times 9.81 \times 1.8} = 5.94 \text{ ms}^{-1}$$

After

$$v^2 = u^2 + 2as$$

$$u = \sqrt{-2 \times -9.81 \times 1.1} = -4.65 \text{ ms}^{-1}$$

$$\Delta p = 58 \times 10^{-3} (5.94 + 4.65) = 0.614 \text{ kg ms}^{-1}$$

Turn over ►



2 | 7

A mass M is suspended from a spring. When the mass is at rest at the equilibrium position, the elastic potential energy stored is E .
An extra mass of $2M$ is added to the spring and the spring extends while still obeying Hooke's law.

What is the total elastic energy stored when the system is at rest at the new equilibrium position?

A $2E$ B $3E$ C $4E$ D $9E$

[1 mark]

$$E = \frac{1}{2} F \Delta L$$

$$F = k \Delta L$$

$$\therefore \Delta L \propto F \propto m$$

$$F = mg$$

$$\therefore F \propto m$$

$$E \propto m^2$$

$$E_1 \propto M^2$$

$$E_2 \propto (M+2M)^2 = 9M^2$$

$$E_2 = 9E_1$$

2 | 8

Two wires P and Q are made of the same material and have the same cross-sectional area.

P has an original length L and is subject to a tensile force F . P extends a distance x .
Q has an original length $2L$ and is subject to a tensile force $2F$.

Which statement is correct?

$$\sigma_P = F/A \quad \sigma_Q = 2F/A$$

[1 mark]

A The stress in P and the stress in Q are the same. \times B The extension of Q is $2x$ \times $x_P = \frac{FL}{EA}$ $x_Q = \frac{2F \cdot 2L}{EA}$ C The strain of Q is double the strain of P. D The value of $\frac{\text{stress}}{\text{strain}}$ for P is half that of Q. \times

$$E_P = E_Q$$

$$\epsilon_P = \frac{x}{L}$$

$$\epsilon_Q = \frac{4x}{2L} = \frac{2x}{L}$$

2 | 9

The current in a metallic conductor is 1.5 mA.

How many electrons pass a point in the conductor in two minutes?

[1 mark]

A 1.1×10^{18} B 1.9×10^{19} C 1.4×10^{20} D 2.0×10^{29}





$$Q = It \quad \text{and} \quad Q = ne$$

$$n = \frac{It}{e} = \frac{1.5 \times 10^{-3} \times 2 \times 60}{1.60 \times 10^{-19}}$$

$$n = 1.125 \times 10^{18}$$

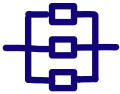

3 0 Which value of resistance **cannot** be made by combining three $10\ \Omega$ resistors? [1 mark]

- A $3.3\ \Omega$ 
- B $6.7\ \Omega$ 
- C $15\ \Omega$ 
- D $25\ \Omega$ 

3 1 A particle performs simple harmonic motion with a time period of $1.4\ \text{s}$ and an amplitude of $12\ \text{mm}$.

What is the maximum speed of the particle?

[1 mark]

- A $8.6\ \text{mm s}^{-1}$
- B $27\ \text{mm s}^{-1}$
- C $54\ \text{mm s}^{-1}$
- D $110\ \text{mm s}^{-1}$

$$v_{\max} = \omega A = \frac{2\pi}{T} A$$

$$v_{\max} = \frac{2\pi}{1.4} \times 12 \times 10^{-3}$$

$$= 0.0539\ \text{ms}^{-1}$$

25

END OF QUESTIONS



There are no questions printed on this page

*Do not write
outside the
box.*

**DO NOT WRITE ON THIS PAGE
ANSWER IN THE SPACES PROVIDED**



